



***Glass Frosters***  
*Models FR-CN-0660-PC, 1270-PC*  
*Items 50073, 50074*  
***Instruction Manual***



**STOP**  
**DO NOT RETURN**  
**THIS PRODUCT TO THE STORE**

For questions or assistance with this product call OMcan Toll Free: 1 800 465 0234 Customer Service or visit the Support section of [www.omcan.com](http://www.omcan.com)

*Revised - 07/28/2017*



Toll Free: 1-800-465-0234  
Fax: 905-607-0234  
Email: [service@omcan.com](mailto:service@omcan.com)  
[www.omcan.com](http://www.omcan.com)

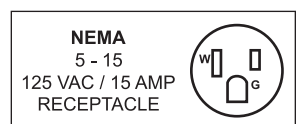

# ***Table of Contents***

Model FR-CN-0660-PC / Model FR-CN-1270-PC

---

<b>Section</b>	<b>Page</b>
General Information -----	3 - 4
Safety and Warranty -----	4 - 5
Technical Specifications -----	6
Installation and Operation -----	6 - 7
Maintenance -----	7 - 8
Troubleshooting -----	8 - 9
Controller Instructions -----	10 - 15
Parts Breakdown -----	15 - 18
Electrical Schematics -----	19 - 20
Notes -----	21 - 22
Warranty Registration -----	23



# General Information

---

Omcan Manufacturing and Distributing Company Inc., Food Machinery of America, Inc. dba Omcan and Omcan Inc. are not responsible for any harm or injury caused due to any person's improper or negligent use of this equipment. The product shall only be operated by someone over the age of 18, of sound mind, and not under the influence of any drugs or alcohol, who has been trained in the correct operation of this machine, and is wearing authorized, proper safety clothing. Any modification to the machine voids any warranty, and may cause harm to individuals using the machine or in the vicinity of the machine while in operation.

## CHECK PACKAGE UPON ARRIVAL

Upon receipt of an Omcan shipment please inspect for external damage. If no damage is evident on the external packaging, open carton to ensure all ordered items are within the box, and there is no concealed damage to the machine. If the package has suffered rough handling, bumps or damage (visible or concealed), please note it on the bill of lading before accepting the delivery and contact Omcan within 24 hours, so we may initiate a claim with the carrier. A detailed report on the extent of the damage caused to the machine must be filled out within three days, from the delivery date shown in the shipping documents. Omcan has no recourse for damaged products that were shipped collect or third party.

**Before operating any equipment, always read and familiarize yourself with all operation and safety instructions.**

Omcan would like to thank you for purchasing this machine. It's of the utmost importance to save these instructions for future reference. Also save the original box and packaging for shipping the equipment if servicing or returning of the machine is required.

---

Omcan Fabrication et distribution Compañie Limité et Food Machinery d'Amérique, dba Omcan et Omcan Inc. ne sont pas responsables de tout dommage ou blessure causé du fait que toute personne ait utilisé cet équipement de façon irrégulière. Le produit ne doit être exploité que par quelqu'un de plus de 18 ans, saine d'esprit, et pas sous l'influence d'une drogue ou d'alcool, qui a été formé pour utiliser cette machine correctement, et est vêtu de vêtements de sécurité approprié. Toute modification de la machine annule toute garantie, et peut causer un préjudice à des personnes utilisant la machine ou des personnes à proximité de la machine pendant son fonctionnement.

## VÉRIFIEZ LE COLIS DÈS RÉCEPTION

Dès réception d'une expédition d'Omcan veuillez inspecter pour dommages externes. Si aucun dommage n'est visible sur l'emballage externe, ouvrez le carton afin de s'assurer que tous les éléments commandés sont dans la boîte, et il n'y a aucun dommage dissimulé à la machine. Si le colis n'a subi aucune mauvaises manipulations, de bosses ou de dommages (visible ou cachée), notez-le sur le bond de livraison avant d'accepter la livraison et contactez Omcan dans les 24 heures qui suivent, pour que nous puissions engager une réclamation auprès du transporteur. Un rapport détaillé sur l'étendue des dommages causés à la machine doit être rempli dans un délai de trois jours, à compter de la date de livraison indiquée dans les documents d'expédition. Omcan n'a aucun droit de recours pour les produits endommagés qui ont été expédiés ou cueilli par un tiers transporteur.

# ***General Information***

---

Avant d'utiliser n'importe quel équipement, toujours lire et vous familiariser avec toutes les opérations et les consignes de sécurité.

Omcan voudrais vous remercier d'avoir choisi cette machine. Il est primordial de conserver ces instructions pour une référence ultérieure. Également conservez la boîte originale et l'emballage pour l'expédition de l'équipement si l'entretien ou le retour de la machine est nécessaire.

---

Omcan Empresa De Fabricacion Y Distribucion Inc. Y Maquinaria De Alimentos De America, Inc. dba Omcan y Omcan Inc. no son responsables de ningun daño o perjuicio causado por cualquier persona inadecuada o el uso descuidado de este equipo. El producto solo podra ser operado por una persona mayor de 18 años, en su sano juicio y no bajo alguna influencia de droga o alcohol, y que este ha sido entrenado en el correcto funcionamiento de esta máquina, y ésta usando ropa apropiada y autorizada. Cualquier modificación a la máquina anula la garantía y puede causar daños a las personas usando la máquina mientras esta en el funcionamiento.

## **REVISE EL PAQUETE A SU LLEGADA**

Tras la recepcion de un envio Omcan favor inspeccionar daños externos. Si no hay daños evidentes en el empaque exterior, Habra el carton para asegurarse que todos los articulos solicitados estén dentro de la caja y no encuentre daños ocultos en la máquina. Si el paquete ha sufrido un manejo de poco cuidado, golpes o daños (visible o oculto) por favor anote en la factura antes de aceptar la entrega y contacte Omcan dentro de las 24 horas, de modo que podamos iniciar una reclamación con la compañía. Un informe detallado sobre los daños causados a la máquina debe ser llenado en el plazo de tres días, desde la fecha de entrega que se muestra en los documentos de envío. Omcan no tiene ningun recurso por productos dañados que se enviaron a recoger por terceros.

Antes de utilizar cualquier equipo, siempre lea y familiarizarse con todas las instrucciones de funcionamiento y seguridad.

Omcan le gustaría darle las gracias por la compra de esta máquina. Es de la mayor importancia para salvar estas instrucciones para futuras consultas. Además, guarda la caja original y el embalaje para el envío del equipo si servicio técnico o devolución de la máquina que se requiere.

# ***Safety and Warranty***

---

Please pay close attention to the safety notices in this section. Disregarding these notices may lead to serious injury and/or damage to the unit.

## **ATTENTION**

- To minimize shock and fire hazards, be sure not to overload outlet. Please Designate one outlet for your unit.
- Do not use extension cords.

# *Safety and Warranty*

---

- Do not put your hands under the unit when the units is required to be moved.
- When the unit is not in use for a long period o time, please unplug the unit from the outlet.
- After unplugging the unit, wait at least 10 minutes before re-plugging it. Failure to do so could cause damage to the compressor.

## **UNPLUG CORD**

- To minimize shock and fire hazards, please do not plug or unplug the cord with wet hands.
- During maintenance and cleaning, please unplug the unit.

## **PROPER GROUNDING REQUIRED**

- To minimize shock and fire hazards, make sure that the unit is properly grounded.

## **PROHIBITION**

- Do not attempt to remove or repair any component unless instructed by factory.
- Make sure that the unit is not resting on or against the electrical cord and plug.
- To minimize personal injury, do not hang on the doors.
- Do not store any flammable and explosive gas or liquids inside the unit.
- Do not attempt to alter or tamper with the electrical cord.
- Do not set the desired temperature out of the recommended temperature range:(Ref: 0°F)

## **1 YEAR PARTS AND LABOUR / 5 YEARS PARTS ONLY COMPRESSOR WARRANTY**

**Within the warranty period, contact Omcan Inc. at 1-800-465-0234 to schedule an Omcan authorized service technician to repair the equipment locally.**

**Unauthorized maintenance will void the warranty. Warranty covers electrical and part failures, not improper use.**

**Please see [www.omcan.com/warranty.html](http://www.omcan.com/warranty.html) for complete info.**

## **WARNING:**

The packaging components are classified as normal solid urban waste and can therefore be disposed of without difficulty.

**In any case, for suitable recycling, we suggest disposing of the products separately (differentiated waste) according to the current norms.**

**DO NOT DISCARD ANY PACKAGING MATERIALS IN THE ENVIRONMENT!**

# Technical Specifications

Model	FR-CN-0660-PC	FR-CN-1270-PC
Temperature Range	-17.8 - -15°C / 0 - 5°F	
Capacity	90 (8" Mugs)	250 (8" Mugs)
	85 (10oz. Steins)	240 (10oz. Steins)
	150L	400L
Electrical	115V / 60Hz / 1	
HP	1/5HP	+1/4HP
# of Shelves	2	5
Refrigerant	R290	
Dimensions	26.4" x 26.7" x 34.2" 670 x 677 x 869mm	49.5" x 26.7" x 34.2" 1257 x 677 x 869mm
Item Number	50073	50074

# Installation and Operation

## IMPORTANT! PLEASE READ BEFORE INSTALLATION

- If the unit has recently been transported. Please let unit stand still for a minimum of 24 hours before plugging it in.
- Make sure that the unit drops down to desired temperature before loading the unit with product.
- Make sure that there is proper ventilation around the unit in the area where it will operate.
- Make sure all accessories are installed (i.e. shelves, shelf clips, casters) before plugging the unit in.
- Please read through the Operation / Owners Manual in its entirety.

## CABINET LOCATION GUIDELINES

- Install the unit on strong and leveled surfaces.
  - Unit may make unpleasant noises if surface is uneven.
  - Unit may malfunction if surface is uneven.
- Install the unit in an indoor, well-ventilated area.
  - Unit performs more efficiently in a well-ventilated area.
  - For best performance, please maintain clearance of 4" on the back of the unit.
  - Outdoor use may cause decreased efficiency and damage to the unit.
- Avoid installation in a high humidity and/or dusty area.
  - Humidity could cause unit to rust and decrease efficiency of the unit.
  - Dust collected on condenser coil will cause unit to malfunction. Clean the condenser at least once a month with a brush or clean cloth.
- Select a location away from heat and moisture-generating equipment.
  - High ambient temperature will cause the compressor to overwork, leading to higher emergency bills and gradual breakdown of the unit.



# Installation and Operation

---

## **ELECTRICAL**

Please ensure that the required voltage of the compressor is being supplied at all times. Low or high voltage can detrimentally affect the refrigeration unit. All units should be plugged into a grounded and properly-sized electrical outlet with appropriate overcurrent protection. Please refer to the electrical requirement on the nameplate. Please make sure that your unit has its own dedicated outlet. Do not use an extension cord.

## **TEMPERATURE CONTROLS**

The temperature controls are factory-set to maintain an average temperature of 0°F in refrigeration. Allow unit to function several hours, completely cooling cabinet before changing the control setting.

## **TEMPERATURE CONTROL LOCATION AND SETTINGS**

- Digital temperature control is located on the front of or the rear of the unit.
- Mechanical temperature control is located inside of unit.

## **LOADING PRODUCT**

The bin dividers have been installed at the factory for your convenience. Feel free to reposition the dividers as you see fit. To remove the bin dividers, simply push the divider towards the back wall until the front of the divider is removed from the positioning holes. To install, position the divider to the desired holes, making sure that the pressure spring is installed properly.

**NOTE: If the unit is disconnected or shut off, wait five minutes before starting again.**

**RECOMMENDATION** - Before loading product we recommend you run your unit empty for two to three days. This allows you to be sure electrical wiring and installation are correct and no shipping damage has occurred.

**PAY CLOSE ATTENTION TO THE LOAD LIMIT STICKERS LOCATED ON THE INTERIOR WALLS TO THE UNIT. DO NOT LOAD PRODUCT ABOVE THE LOAD LIMIT STICKERS OR ABOVE THE TOP CROSS BAR OF THE BIN DIVIDERS. LOADING PRODUCT ABOVE THE LOAD LIMIT STICKERS WILL HARM THE PERFORMANCE OF THE UNIT.**

## **CAUTION**

Setting the temperature control to the coldest setting may cause the Evaporator coil to freeze and ice up. This will eventually result in a warmer cabinet temperature.

# Maintenance

---

## **CLEANING THE CONDENSER COIL**

- For efficient operation, it is important that the condenser surface be kept free of dust, dirt, and lint.
- We recommend cleaning the condenser coil and fins at least once per month.
- Clean with a commercial condenser coil cleaner, available from any kitchen equipment retailer. Brush the condenser fins from top to bottom, not side to side.
- After cleaning, straighten any bent condenser fins with a fin comb.

# Maintenance

---

## CLEANING THE FAN BLADE AND MOTOR

- If necessary, clean the fan blades and motor with a soft cloth, if it is necessary to wash the fan blades, cover the fan motor to prevent moisture damage.

## CLEANING THE INTERIOR OF UNIT

- When cleaning the cabinet interior, use a solvent of warm water and mild soap.
- Do not use steel wool, caustic soap, abrasive cleaners, or bleach that may damage the stainless steel surface.
- Wash door gaskets on a regular basis, preferably weekly. Simply remove door gasket from the frame of the door, soak in warm water and soap for thirty (30) minutes, dry with soft cloth, and replace.
- Check door gaskets for proper seal after they are replaced.
- Periodically remove the shelves and pilasters from the unit and clean them with mild soap and warm water. To remove the pilasters, first remove the shelves and shelf brackets. Then, simply lift the pilaster up and out.

## WARNING

Disconnect power cord before cleaning any parts of the unit.

# Troubleshooting

---

Before requesting any service on your unit, please check the following points. Please note that this guide serve only as a reference for solutions to common problems.

SYMPTOM	POSSIBLE CAUSE	CORRECTIVE ACTION
Compressor not running.	Fuse blown or circuit breaker tripped.	Replace fuse or reset circuit breaker.
	Power cord unplugged.	Plug in power cord.
	Thermostat set too high.	Set thermostat to lower temperature.
	Cabinet in defrost cycle.	Wait for defrost cycle to finish.



# Troubleshooting

Condensing unit runs for long periods of time.	Excessive amount of warm product placed in cabinet.	Allow adequate time for product to cool down.
	Prolonged door opening or door ajar.	Ensure doors are closed when not in use. Avoid opening doors for long periods of time.
	Door gasket(s) not sealing properly.	Ensure gaskets are snapped in completely. Remove gasket and wash with soap and water.
		Check condition of gasket and replace if necessary.
	Dirty condenser coil.	Clean the condenser coil.
	Evaporator coil iced over.	Unplug unit and allow coil to defrost. Make sure thermostat is not set too cold. Ensure that door gasket(s) are sealing properly.
Cabinet temperature is too warm.	Thermostat set too warm.	Set thermostat to lower Temperature.
	Blocking air flow.	Re-arrange product to allow for proper air flow. Make sure there is at least four inches of clearance from evaporator.
	Excessive amount of warm product placed in cabinet.	Allow adequate time for product to cool down.
	Fuse blown or circuit breaker tripped.	Replace fuse or reset circuit breaker.
	Dirty condenser coil.	Clean the condenser coil.
	Prolonged door opening or door ajar.	Ensure doors are closed when not in use. Avoid opening doors for long periods of time.
	Evaporator coil iced over.	Unplug unit and allow coil to defrost. Make sure thermostat is not set too cold. Ensure that door gasket(s) are sealing properly.
Cabinet is noisy.	Loose part(s).	Locate and tighten loose part(s).
	Tubing vibration.	Ensure tubing is free from contact with other tubing or components.

# Controller Instructions

Digital controller model: PJEZ for cooler



Dimensioni (mm) / Dimensions (mm)

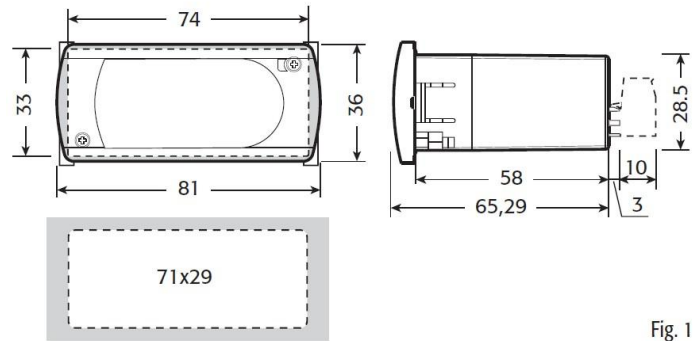







Fig. 1

## Display and functions



During normal operation, the controller displays the value of the probe set using parameter/4(=1 ambient probe, default, = 2 second probe, = 3 third probe). In addition, the display has LEDs that indicate the activation of the control functions (see Table 1), while the 3 buttons can be used to activate/deactivate some of the functions (see Table 2).

### LED's and Associated Functions (Table 1)

Icon	Function	Normal Operation			Start Up
		ON	OFF	Blink	
	Compressor	On	Off	Request	ON
	Fan	On	Off	Request	ON
	Defrost	On	Off	Request	ON
<i>AUX</i>	Aux	Output On	Output Off	-	ON
	Alarm	All	No Alarm	-	ON
	Clock	RTC fitted and enabled, at least 1 time band set	RTC not fitted or disabled, not even 1 time band set	-	ON if RTC fitted

# Controller Instructions

**Table of Functions activated by the buttons - Models S, X, Y, C (Table 2)**

Button		Normal Operation		Start Up	
		Pressing the Button Alone	Pressed Together		
	Up ON/OFF	More than 3 sec: toggle ON/OFF	Start/Stop continuous cycle	-	
	Down Defrost	More than 3 sec: start/stop defrost			
	Set Mute	- 1 sec.: display/set the set point. - more than 3 secs.: access parameter setting menu (enter password ) - mute audible alarm (buzzer)	-	Pressed together Start parameter reset procedure	For 1 sec. display firmware vers. code
					For 1 sec. RESET current EZY set

## Setting the set point (desired temperature)

- Press **SET** for 1 sec, the set value will start flashing after a few moments.
- Increase or decrease the value using **UP** or **DOWN**.
- Press **SET** to confirm the new value.

## Switching the device ON/OFF

Press **UP** for more than 3 sec. The control and defrost algorithms are now disabled and the Instrument displays the message “OFF” alternating with the temperature read by the set probe

## Manual defrost

Press for **DOWN** more than 3 sec (the defrost starts only the temperature conditions are valid).

## Continuous cycle

Press **UP** and **DOWN** together for more than 3 sec.

## Access and setting type F (frequent) and type C (configuration) parameters

1. Press **SET** for 3 sec (the display will show “PS”).
2. • To access the type F and C parameter menu, enter the password “22” using **UP/DOWN**, press **SET** to confirm.  
• To access the F parameter menu only, press **SET** (without entering the password).
3. Scroll inside the parameter menu using **UP/DOWN**.

# Controller Instructions

- To display/set the values of the parameter displayed, press **SET**, then **UP/DOWN** and finally **SET** to confirm the changes (returning to the parameter menu).

To save all the new values and exit the parameter menu, press **SET** for 3 s.

To exit the menu without saving the changed values (exit by timeout) do not press any button for at least 60 s.

## Digital controller model: IR33 for freezer



Montaggio a pannello ir33/ir33 panel mounting:

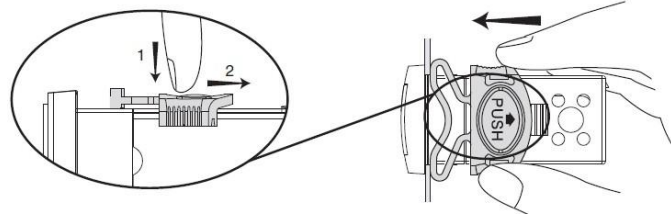



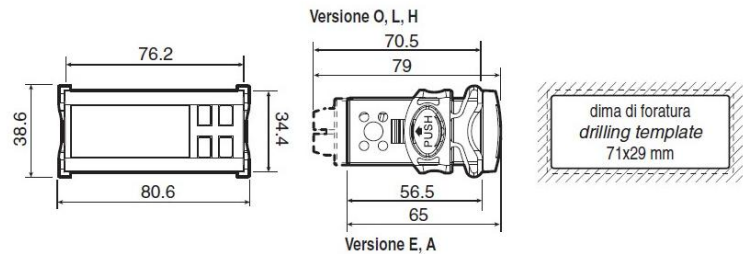

Montaggio a pannello mediante due staffe plastiche a scorrimento laterale  
Panel mounting by two lateral sliding plastic brackets

Dimensioni (mm) /Dimensions (mm)





## Signals on the display

The blinking status indicates a request for activation that cannot be implemented until the end of the Corresponding delay times.

Icon	Function	ON	OFF	Blink	Startup
	Compressor	Compressor on	Compressor off	Request	
	Fan	Fan on	Fan off	Request	
	Defrost	Defrost in progress	Defrost not required	Request	
AUX	Aux	Auxiliary Output AUX active	Auxiliary Output AUX not active	Anti-sweat heater function active	
	Alarm	Delayed external alarm (before the expiry of the time 'A7')	No alarm present	Alarms in normal operation (eg. high/low temp.) or alarm from ext. digital input immediate or delayed	
	Clock	At least one timed defrost has been set	No timed defrost is present	Clock alarm	On if Real-Time Clock present

# Controller Instructions

	Light	Auxiliary output light active	Auxiliary output light not active	Anti-sweat heater function active	
	Service		No malfunction	Malfunction (eg. EEPROM error or probe fault)	
HACCP	HACCP	HACCP function	HACCP function enabled	HACCP alarm (HA and/or HF) not enabled	
	Continuous Cycle	Enabled	Not enabled	Request	

## Setting the set point (desired temperature value)

To display or set the set point, proceed as follow:

1. Press the “Set” button for more than 1 second to display the set point.
2. Increase or decrease the value of the set point, using the “ $\frac{\Delta}{aux}$ ” and “ $\frac{def}{\nabla}$ ” respectively, until reaching the desired value.
3. Press the “Set” button again to confirm the new value.

## Alarms with manual reset

The alarms with manual reset can be reset by pressing the “ $\frac{Prg}{mute}$ ” and “ $\frac{\Delta}{aux}$ ” for more than 5 sec.

## Manual defrost

As well as the automatic defrost function, a manual defrost can be enabled, if the temperature conditions allow, by pressing the “ $\frac{def}{\nabla}$ ” button for more than 5 sec.

## Continuous cycle

Pressing the buttons “ $\frac{\Delta}{aux}$ ” and “ $\frac{def}{\nabla}$ ” simultaneously for more than 5 seconds enables the continuous cycle function. During operation in continuous cycle, the compressor continues to operate for the time “cc” and it stops when it reaches the “cc” time out or the minimum temperature has been reached (AL = minimum temperature alarm threshold). Continuous cycle setting: “cc” parameter (continuous cycle duration): “cc”=0 never active; “c6” parameter (by passing the alarm after the continuous cycle): “cc” = 0 never active; it avoid or delays the low temperature alarm after the continuous cycle.

## Accessing the configuration parameter (type C)

1. Pressing the “ $\frac{Prg}{mute}$ ” and “Set” buttons at the same time for more than 5 sec, the display will show “00”(password prompt).
2. Use the “ $\frac{\Delta}{aux}$ ” or “ $\frac{def}{\nabla}$ ” buttons to display the number “22” (parameter access password).
3. Confirm by pressing “Set”.
4. The display will show the first modifiable “C” parameter.

# Controller Instructions

---

## Accessing the configuration parameter (type F)

1. Hold the " $\frac{\text{Prg}}{\text{mute}}$ " button for more than 5 s (if there are active alarms, first mute the buzzer), the display will show the first modifiable "F" parameter.

## Modifying the parameters

After having displayed the parameter, either type "C" or type "F", proceed as follows:

1. Use the " $\frac{\blacktriangle}{\text{aux}}$ " or " $\frac{\blacktriangledown}{\text{def}}$ " buttons to scroll the parameters, until reaching the parameter to be modified; when scrolling the parameters, an icon is shown on the display that represents the category of the parameter.
2. Alternatively, press the " $\frac{\text{Prg}}{\text{mute}}$ " button to display a menu that can be used to quickly access the family of parameters to be modified.
3. Scrolling the menu using the " $\frac{\blacktriangle}{\text{aux}}$ " and " $\frac{\blacktriangledown}{\text{def}}$ " buttons displays the codes of the various categories of parameter, accompanied by the corresponding icon on the display(if present).
4. Once having reached the desired category, press "**Set**" to go directly to the first parameter in the chosen category(if no parameter is visible, pressing the "**Set**" button will have no effect).
5. At this stage, modify the parameters or return to the "Category" menu, using the " $\frac{\text{Prg}}{\text{mute}}$ " button.
6. Press "**Set**" to display the value associated with the parameter.
7. Increase or decrease the value using the " $\frac{\blacktriangle}{\text{aux}}$ " or " $\frac{\blacktriangledown}{\text{def}}$ " buttons respectively.
8. Press "**Set**" to temporarily save the new value and return to the display of the parameter.
9. Repeat the operation from point 1 or point 2.
10. If the parameter has sub-parameters, press "**Set**" to display the first sub-parameter.
11. Press the " $\frac{\blacktriangle}{\text{aux}}$ " or " $\frac{\blacktriangledown}{\text{def}}$ " button to display all the sub-parameters.
12. Press "**Set**" to display the associated value.
13. Increase or decrease the value using the " $\frac{\blacktriangle}{\text{aux}}$ " or " $\frac{\blacktriangledown}{\text{def}}$ " button respectively.
14. Press "**Set**" to temporarily save the new value and return to the display of the sub-parameter code.
15. Press " $\frac{\text{Prg}}{\text{mute}}$ " to return to the display of the parent parameter.

## Saving the new values assigned to the parameters

To definitely save the new values of the modified parameters, press the " $\frac{\text{Prg}}{\text{mute}}$ " button for more than 5 seconds, thus exiting the parameter setting procedure. All the modification made to the parameters temporarily saved in the RAM, can be cancelled and "normal operation" resumed by not pressing any button for 60 seconds, thus allowing the parameter setting session to expire due to timeout if the Instrument is switched off before pressing the " $\frac{\text{Prg}}{\text{mute}}$ " button, all the modifications made to the parameters and temporarily saved will be lost.



# Controller Instructions

## REFERENCE

Item Number	Model Number	Description	Manufacturer Model Number
50073	FR-CN-0660-PC	Glass Froster / Plate Chiller 26" / 660mm 115V/60/1 Black cETLus/ETL	GF-25-HC
50074	FR-CN-1270-PC	Glass Froster / Plate Chiller 50" / 1270mm 115V/60/1 Black cETLus/ETL	GF-50-HC

## Parts Breakdown

### Model FR-CN-0660-PC 50073

Item No.	Description	Position	Item No.	Description	Position	Item No.	Description	Position
62355	Compressor Unit Installation Board for GF-25-HC	1	62369	Top Board for GF-25-HC	16	62380	Drain Pan for GF-25-HC	31
62356	Limit Block for Compressor Installation Board for GF-25-HC	2	62370	Base Board for Lock for GF-25-HC	17	62381	Right Rail for Installation Board for GF-25-HC	32
62357	Adjustable Feet for GF-25-HC	3	62371	Evaporator Fan Baffle (Left and Right) for GF-25-HC	18	62382	Fixed Strip for Front Grill for GF-25-HC	33
62358	Cabinet Base for GF-25-HC	4	62372	Evaporator Fan Motor Cover for GF-25-HC	19	62383	Controller Water Proof Box for GF-25-HC	34
62359	Front Grill for GF-25-HC	5	62373	Evaporator Fan Baffle (Bottom) for GF-25-HC	20	62384	Power Switch for GF-25-HC	35
62360	Back Grill for GF-25-HC	6	26228	Evaporator Fan Motor for GF-25-HC	21	24293	Controller for GF-25-HC	36
62361	Door for GF-25-HC	7	62374	Evaporator for GF-25-HC	22	62385	Controller Panel for GF-25-HC	37
62362	Door Gasket for GF-25-HC	8	62375	Evaporator Cover for GF-25-HC	23	62321	Drain Tube (Φ16mm) for GF-25-HC	38
62363	Door Handle for GF-25-HC	9	62376	Defrost Pipe for GF-25-HC	24	62387	Left Rail for Installation Board for GF-25-HC	39
62364	Shelf for GF-25-HC	10	62377	Inner Drain Pan for GF-25-HC	25	62388	Power Plug for GF-25-HC	40
62365	Shelf Rail for GF-25-HC	11	62378	Compressor for GF-25-HC	26	26189	Filter for GF-25-HC	41
62366	Panel Under Table for GF-25-HC	12	26233	Condenser Fan Motor Cover for GF-25-HC	27	26188	Filter Fixer for GF-25-HC	42
62367	Under Table Component for GF-25-HC	13	26234	Condenser Fan Blade for GF-25-HC	28	62389	Inner Drain Pipe for GF-25-HC	43
62368	Key for GF-25-HC	14	24293	Condenser Fan Motor for GF-25-HC	29	62390	Door Limit Block for GF-25-HC	44
61464	Lock for GF-25-HC	15	62379	Condenser for GF-25-HC	30	62391	Back Limit Block for GF-25-HC	45

# Parts Breakdown

Model FR-CN-0660-PC 50073

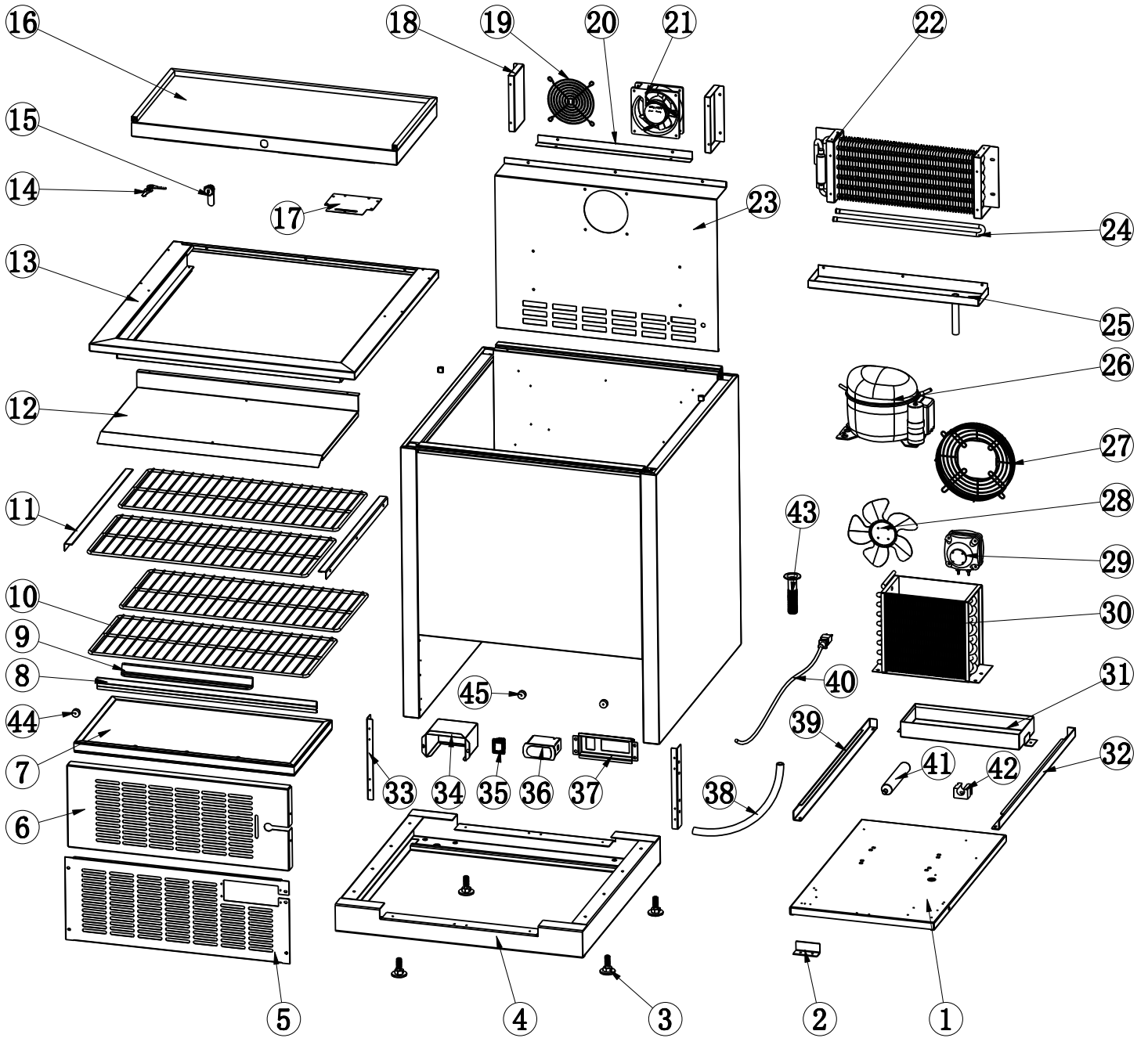



# Parts Breakdown

## Model FR-CN-1270-PC 50074

Item No.	Description	Position	Item No.	Description	Position	Item No.	Description	Position
62355	Compressor Unit Installation Board for GF-50-HC	1	62399	Decoration Strip for GF-50-HC	18	62405	Bottle Opener for GF-50-HC	35
62392	Base Board for GF-50-HC	2	62369	Top Board for GF-50-HC	19	62406	Drain Pan Supporting Board for GF-50-HC	36
62389	Inner Drain Pipe for GF-50-HC	3	62400	Left Support for Evaporator Cover for GF-50-HC	20	62407	Rail for Drain Pan Supporting Board for GF-50-HC	37
62357	Adjustable Feet for GF-50-HC	4	62375	Evaporator Cover for GF-50-HC	21	62378	Compressor for GF-50-HC	38
62358	Cabinet Base for GF-50-HC	5	62372	Evaporator Fan Motor Cover for GF-50-HC	22	24293	Condenser Fan Motor for GF-50-HC	39
62361	Door for GF-50-HC	6	26228	Evaporator Fan Motor for GF-50-HC	23	26234	Condenser Fan Blade for GF-50-HC	40
62363	Door Handle for GF-50-HC	7	62377	Inner Drain Pan for GF-50-HC	24	26233	Condenser Fan Motor Cover for GF-50-HC	41
62362	Door Gasket for GF-50-HC	8	62401	Cabinet for GF-50-HC	25	26189	Filter for GF-50-HC	42
62390	Door Limit Block for GF-50-HC	9	62402	Right Support for Evaporator Cover for GF-50-HC	26	26188	Filter Fixer for GF-50-HC	43
62393	Rail 1 for GF-50-HC	10	62391	Back Limit Block for GF-50-HC	27	62321	Drain Tube (φ16mm) for GF-50-HC	44
62394	Lower Shelf for GF-50-HC	11	62403	Back Grill for GF-50-HC	28	26184	Condenser for GF-50-HC	45
62395	Upper Shelf for GF-50-HC	12	62380	Drain Pan for GF-50-HC	29	62408	Outer Drain Pan for GF-50-HC	46
62396	Panel Under Table for GF-50-HC	13	62385	Controller Panel for GF-50-HC	30	62388	Power Plug for GF-50-HC	47
62397	Under Table Component for GF-50-HC	14	24293	Controller for GF-50-HC	31	72280	Key for GF-50-HC	48
61464	Lock for GF-50-HC	15	62384	Power Switch for GF-50-HC	32	62383	Controller Water Proof Box for GF-50-HC	49
62370	Base Board for Lock for GF-50-HC	16	62404	Evaporator for GF-50-HC	33	62409	Controller Protecting Board for GF-50-HC	50
62398	Decoration Cover for GF-50-HC	17	62376	Defrost Pipe for GF-50-HC	34	62410	Front Grill for GF-50-HC	51

# Parts Breakdown

Model FR-CN-1270-PC 50074

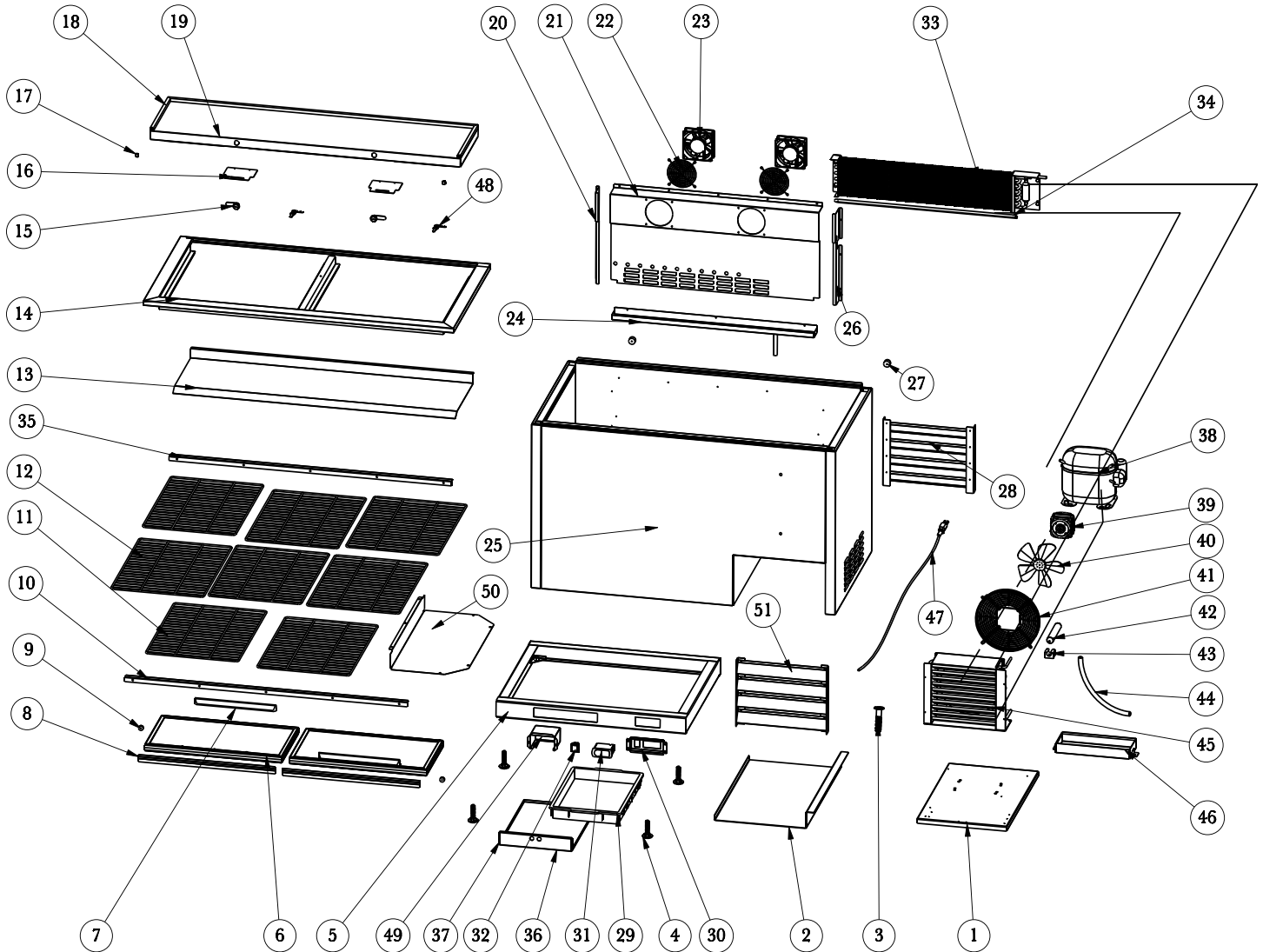

# Electrical Schematics

Model FR-CN-0660-PC 50073

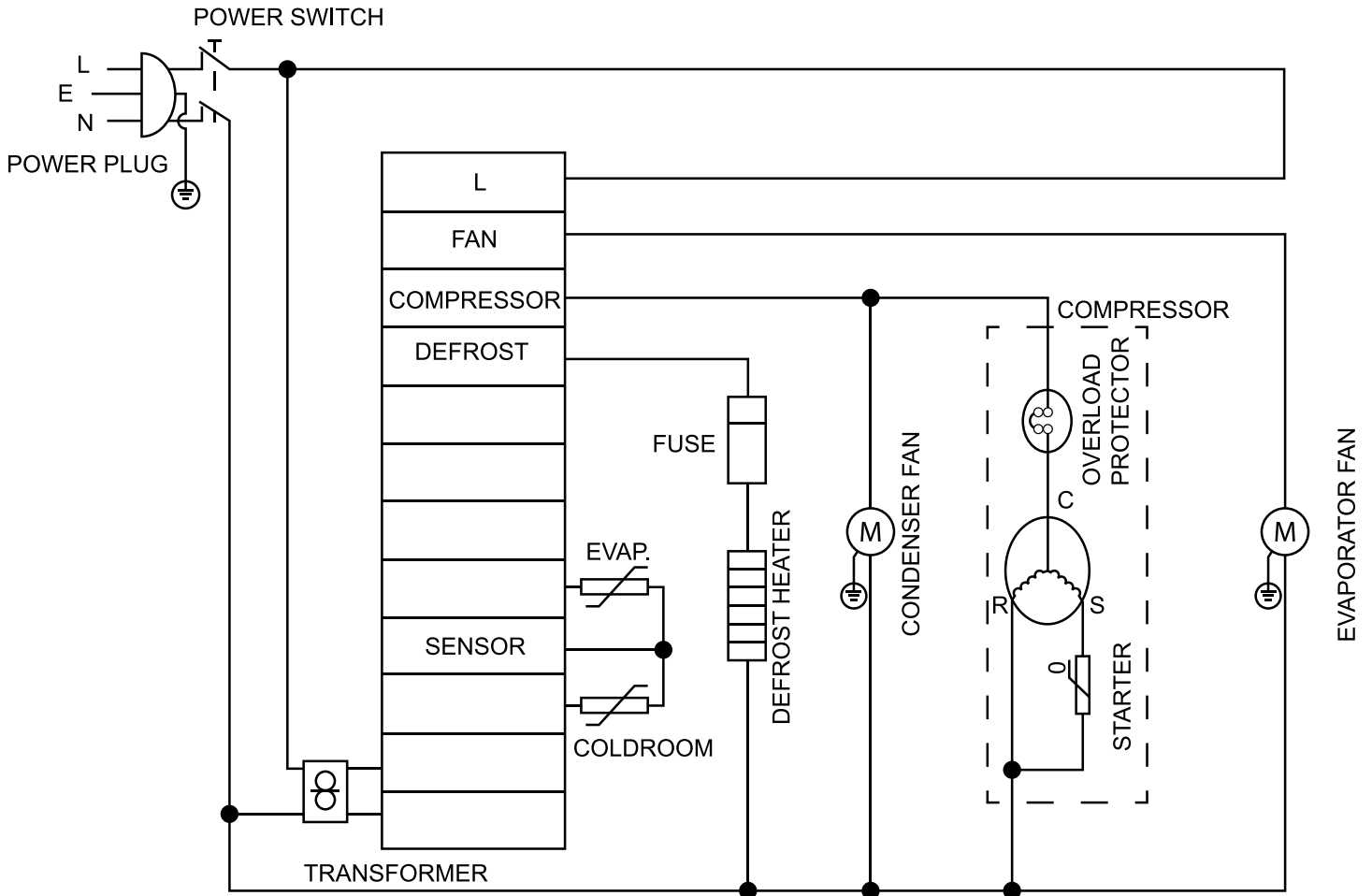

# Electrical Schematics

Model **FR-CN-1270-PC** 50074

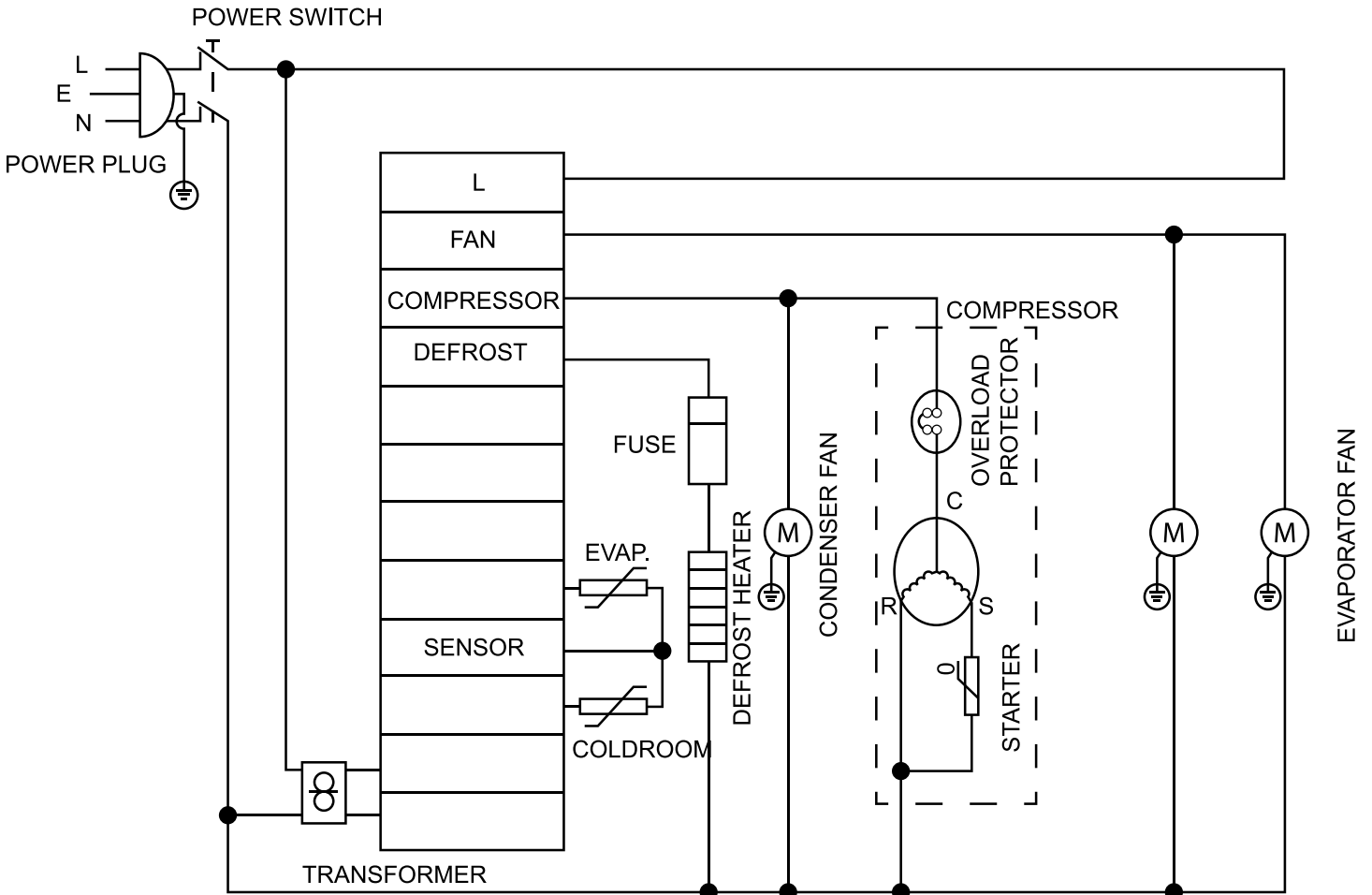







# Warranty Registration

Thank you for purchasing an Omcan product. To register your warranty for this product, complete the information below, tear off the card at the perforation and then send to the address specified below. You can also register online by visiting:

Merci d'avoir acheté un produit Omcan. Pour enregistrer votre garantie pour ce produit, complétez les informations ci-dessous, détachez la carte au niveau de la perforation, puis l'envoyer à l'adresse spécifiée ci-dessous. Vous pouvez également vous inscrire en ligne en visitant:

Gracias por comprar un producto Omcan usted. Para registrar su garantía para este producto, complete la información a continuación, cortar la tarjeta en la perforación y luego enviarlo a la dirección indicada a continuación. También puede registrarse en línea en:

**[www.omcan.com/warrantyregistration.html](http://www.omcan.com/warrantyregistration.html)**

**For mailing in Canada**

**Pour postale au Canada**

**Por correo en Canadá**

**For mailing in the US**

**Pour diffusion aux États-Unis**

**Por correo en los EE.UU.**

**OMCAN**

PRODUCT WARRANTY REGISTRATION

3115 Pepper Mill Court,

Mississauga, Ontario

Canada, L5L 4X5

**OMCAN**

PRODUCT WARRANTY REGISTRATION

4450 Witmer Industrial Estates, Unit 4,

Niagara Falls, New York

USA, 14305

**or email to: [service@omcan.com](mailto:service@omcan.com)**



**Purchaser's Information**

Name: \_\_\_\_\_

Address: \_\_\_\_\_

City: \_\_\_\_\_ Province or State: \_\_\_\_\_ Postal or Zip: \_\_\_\_\_

Country: \_\_\_\_\_

Dealer from which Purchased: \_\_\_\_\_

Dealer City: \_\_\_\_\_ Dealer Province or State: \_\_\_\_\_

Invoice: \_\_\_\_\_

Model Name: \_\_\_\_\_ Model Number: \_\_\_\_\_

Machine Description: \_\_\_\_\_

Date of Purchase (MM/DD/YYYY): \_\_\_\_\_

Would you like to extend the warranty?  Yes  No

Company Name: \_\_\_\_\_

Telephone: \_\_\_\_\_

Email Address: \_\_\_\_\_

Type of Company:

Restaurant  Bakery  Deli

Butcher  Supermarket  Caterer

Institution (specify): \_\_\_\_\_

Other (specify): \_\_\_\_\_

Serial Number: \_\_\_\_\_

Date of Installation (MM/DD/YYYY): \_\_\_\_\_

**Thank you for choosing Omcan | Merci d'avoir choisi Omcan | Gracias por elegir Omcan**



Since 1951 Omcan has grown to become a leading distributor of equipment and supplies to the North American food service industry. Our success over these many years can be attributed to our commitment to strengthen and develop new and existing relationships with our valued customers and manufacturers. Today with partners in North America, Europe, Asia and South America, we continually work to improve and grow the company. We strive to offer customers exceptional value through our qualified local sales and service representatives who provide convenient access to over 3,500 globally sourced products.

---

Depuis 1951 Omcan a grandi pour devenir un des “leaders” de la distribution des équipements et matériel pour l’industrie des services alimentaires en Amérique du Nord. Notre succès au cours de ces nombreuses années peut être attribué à notre engagement à renforcer et à développer de nouvelles et existantes relations avec nos clients et les fabricants de valeur. Aujourd’hui avec des partenaires en Amérique du Nord, Europe, Asie et Amérique du Sud, nous travaillons continuellement à améliorer et développer l’entreprise. Nous nous efforçons d’offrir à nos clients une valeur exceptionnelle grâce à nos ventes locales qualifiées et des représentants de service qui offrent un accès facile à plus de 3500 produits provenant du monde entier.

---

Desde 1951 Omcan ha crecido hasta convertirse en un líder en la distribución de equipos y suministros de alimentos en América del Norte industria de servicios. Nuestro éxito en estos años se puede atribuir a nuestro compromiso de fortalecer y desarrollar nuevas relaciones existentes con nuestros valiosos clientes y fabricantes. Hoy con socios de América del Norte, Europa, Asia y América del Sur, que trabajan continuamente para mejorar y crecer la empresa. Nos esforzamos por ofrecer a nuestros clientes valor excepcional a través de nuestro local de ventas y representantes de los servicios que proporcionan un fácil acceso a más de 3,500 productos con origen a nivel mundial.

